

***dCS Paganini Clock***  
**Digital Audio Master Clock**  
**with USB to SPDIF converter**

**User Manual**  
**Software Release 2.0x**  
**August 2013**

© Data Conversion Systems Ltd. 2007-2013

**Price UK £8.00 / Euro 12.00**

All rights reserved. No part of this publication may be reproduced, stored in or introduced into a retrieval system, or transmitted in any form, or by any means (electronic, mechanical, photocopying, recording or otherwise) without the prior written permission of *dCS*<sup>1</sup>. Any person who does any unauthorised act in relation to this publication may be liable to criminal prosecution and civil claims for damages.

Information contained in this manual is subject to change without notice, and whilst it is checked for accuracy, no liabilities can be accepted for errors.

---

<sup>1</sup> *dCS* is Data Conversion Systems Ltd. Company registered in England No. 2072115.

## Contents

<b>Using the dCS Paganini Clock for the first time .....</b>	<b>3</b>
What's in the box?	3
Positioning the unit	3
Safety Notice	4
<b>Step-by-Step Guide .....</b>	<b>5</b>
Preliminaries	5
STEP 1 - The GOLDEN RULES for using a Master Clock	6
STEP 2 – Master Clock Applications	7
Connecting the system for DSD	7
Connecting the system for Dual AES	8
Using an External Reference	8
STEP 3 – USB Converter Applications	9
Using the Paganini Clock with a computer and a Paganini DAC	9
A word about Music Playing Software	10
Setting the USB Audio Class	10
Loading the Windows driver for USB Audio Class 2	11
Selecting the Paganini Clock as your Audio Output device	11
<b>Front Panel .....</b>	<b>12</b>
POWER Button	12
MENU Button	12
FREQUENCY Button	12
DITHER Button	12
Remote Control Receiver	13
Display	13
<b>Rear Panel .....</b>	<b>14</b>
Mains inlet	14
Reference Input	14
SPDIF Output	14
Word Clock Outputs	14
USB Interface	15
SUC Connector	15
<b>The Menu .....</b>	<b>16</b>
Using the Menu	17
INFORMATION Menu	18
CLOCK SETTINGS Menu	19
DISPLAY SETTINGS Menu	20
<b>Specification .....</b>	<b>21</b>
<b>Maintenance and Support .....</b>	<b>22</b>
Service and Maintenance	22
Replacing a Blown Mains Fuse	22
Cleaning the case	22
Limited Warranty	23
If you need more help	24
Software History	24

## USING THE *dCS Paganini Clock* FOR THE FIRST TIME

Congratulations on purchasing your *dCS Paganini Clock*.

Before using your unit, please read this section and the Step by Step Guide. This will enable you to set the unit up quickly and safely with your hi-fi system.

From time to time, *dCS* will release updated software on CD that you can install yourself using the **Update** feature. Please check our web-site occasionally to see if new *Paganini* software is available, or consult your dealer.

### What's in the box?

Check that the box contains the following items:

- *dCS Paganini Clock*
- Manual and Menu / Setup Guide
- Power cable
- 2 x BNC cables
- USB cable
- *dCS* USB Audio Class 2 driver disc for Windows
- 2 spare fuses

Notify your dealer as soon as possible if anything is missing or damaged. We suggest that you retain the original packaging for possible future use. If this is not possible, replacement packaging can be ordered from *dCS* or our distributors. Details can be found on our web site at [www.dcsLtd.co.uk](http://www.dcsLtd.co.uk).

The cables supplied are commercial-grade parts, as we realise our customers will want to make their own choices.

The *Paganini Transport* is supplied with a remote control. If you do not have a *Paganini Transport* in your system, a remote control can be ordered direct from *dCS* as an optional extra.

### Positioning the unit

The *Paganini Clock* may be stacked with other products, but the system is likely to give better sonic results when units are mounted on separate shelves of a rack. Place each unit on a firm, vibration free base, allowing convenient connection to the other parts of your system. To prevent overheating, we recommend that you leave some free space around the unit to allow for ventilation.

3 feet are fitted as standard, this may be changed to the 4-foot arrangement shown below, if you prefer. Spare feet are available as an optional extra. The mounting points are M4 size, maximum screw depth is 8mm.

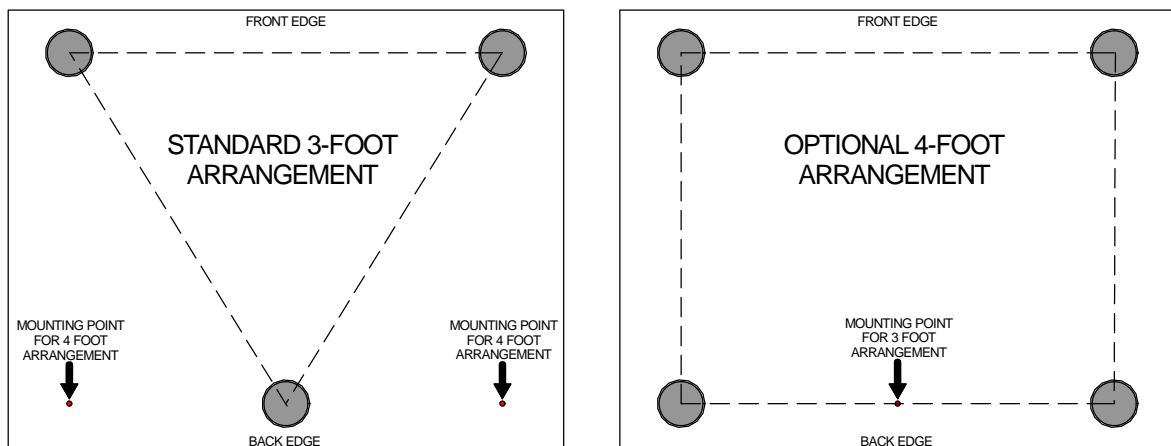

## Safety Notice



Your *dCS Paganini Clock* contains no user serviceable parts. **DO NOT** attempt to open the case as there are potentially dangerous voltages present inside. In the event of the unit developing a fault, please contact your dealer in the first instance.

To maintain protection from electric shock, the unit **MUST** be connected to mains earth (ground) via the power cable. Also, unearthed systems do not give the best sonic performance.



This product is lead-free and complies with the RoHS directive.

Before connecting the power cable to the unit for the first time, please check that it has been set to the correct operating voltage for your mains supply. The unit's voltage setting is shown on the serial number label. If this does not match your local supply voltage, **DO NOT** attempt to use the unit. Contact your dealer to have the unit reset. Using the unit with the wrong mains setting for your local supply may result in serious damage to the unit and will invalidate the warranty. Do not attempt to reset the voltage yourself.

We do not recommend the use of mains regenerators. However, if you do wish to use a mains regenerator with variable voltage and frequency, we recommend that you set the voltage to match your local voltage and the frequency to either 50Hz or 60Hz **ONLY**.



Damage caused to your *Paganini Clock* by misuse of a mains regenerator or by a malfunctioning mains regenerator is not covered by the warranty.



Disposal at end-of-life - the symbol indicates that this product should not be treated as normal household waste. It should be recycled, so please take it to an approved collection facility.

## STEP-BY-STEP GUIDE

This section guides you through setting up the unit for basic operation.

### Preliminaries

The Menu / Setup Guide sheet details the menu structure and details the two most common set-ups.

For digital interfaces, use with cables designed for digital audio:

- for all of the **Word Clock Outputs** and the **Reference Input**, use 75Ω coax cables fitted with BNC plugs.
- for the **SPDIF Output**, use a 75Ω coax cable fitted with RCA Phono plugs.
- for the **USB** interface, use a standard screened USB cable fitted with one type 'A' connector and one type 'B' connector. The internal screen must be connected at both ends.

Connect the power cable supplied to the power inlet on the Clock rear panel, plug the other end into a convenient power outlet.



Please do not use an excessively heavy or inflexible power cable as this may damage the power inlet connector.

Set the rear panel power switch to the **I** position. Briefly press the **Power** button and wait about 30 seconds while the Clock configures itself. The display will show in sequence: **Paganini Clock** and then the clock frequency.

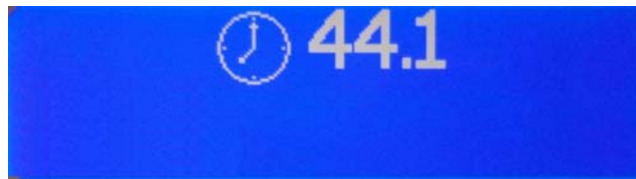

If the unit is likely to be set in an unfamiliar state, you can reset it as follows:

Press the **Menu** button, press the **→** button once, then the **Menu** button again to display the **Clock Settings** menu. Press the **←** button a few times to highlight the **Factory Reset** menu page. Press the **Menu** button and wait a few seconds while the settings are reset.

## STEP 1 - The GOLDEN RULES for using a Master Clock

- **The source equipment MUST be locked to the Master Clock.**  
If it is not, you will either have locking difficulties or hear occasional clicks and the advantages of using the Clock will be lost.  
Most non-*dCS* CD transports, DAB radios, satellite receivers and other equipment do not have a Word Clock Input and so CANNOT be locked to a Master Clock.
- **The clock frequency MUST match the sample rate(s) used in the system.**  
If it does not, the system cannot lock and the DAC may remain muted. Please check the manuals for the equipment used in your system.

When the *Paganini Clock* is set to 44.1kHz, it may be used with DSD-based systems, CD systems without an upsampler running at 44.1kS/s or CD systems upsampling to 88.2kS/s or 176.4kS/s Dual AES. (Some of these units may accept an 88.2kHz clock as an alternative.)

When the *Paganini Clock* is set to 48kHz, it may be used with a DVD player or DAT recorder fitted with a Word Clock Input running at 48kS/s, or upsampling to 96kS/s Dual AES or 192kS/s Dual AES. (Some of these units may accept a 96kHz clock as an alternative.)

The *Scarlatti* and *Paganini Upsamplers* are exceptions to the second rule – we have designed a very flexible clocking arrangement for the *Upsampler* to make it easier to use. It will lock to Word Clock at 32, 44.1, 48, 88.2 or 96kHz, regardless of the input and output sample rates.

To make best use of the *Paganini Clock*, all the digital audio units in the chain should be locked to it.

## STEP 2 – Master Clock Applications

### Connecting the system for DSD

Most owners will use the *Paganini Clock* to clock a *Paganini* stack at 44.1kHz or 88.2kHz.

- If necessary, use the **FREQUENCY** button to set the Clock to **44.1kHz** or **88.2kHz**.
- Connect two of the Clock's **W/Cik Outputs** to the **W/Cik Inputs** of the Transport and DAC.
- Connect a 1394 cable between the DAC and the transport. Select the DAC's **1394** input.
- The transport will automatically slave to the Clock and display **Sync**.
- Use the DAC's **SYNC** button to set it to **W/Cik**.
- Connect the DAC's **Analogue Outputs** to a power amplifier or preamplifier.
- Set the DAC **Volume** control to a suitable level and play a disc.
- Set the Clock's **DITHER** feature on or off as you prefer.

The system will re-lock and un-mute.

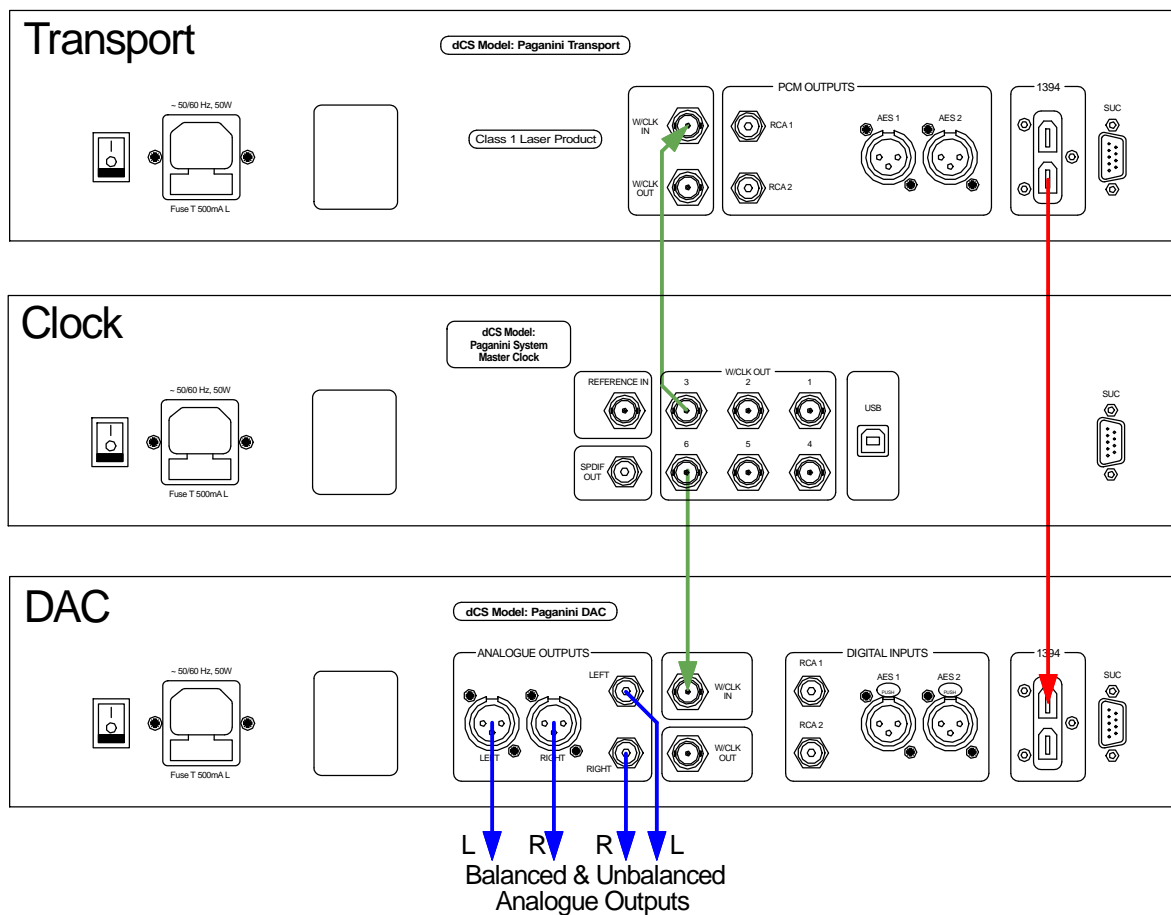

Figure 1 – Using the *Paganini* Transport, DAC and Clock together

### Connecting the system for Dual AES

Owners with an Upsampler may prefer to use it to run the DAC at 176.4kS/s.

- If necessary, use the **FREQUENCY** button to set the Clock to **44.1kHz** or **88.2kHz**.
- Connect two of the Clock's **W/Cik Outputs** to the Word Clock inputs of the Transport, the Upsampler and the DAC.
- Connect an AES cable between the transport's AES output and the Upsampler's AES input, select that input.
- Set the Upsampler to output **176.4kS/s**.
- Connect the Upsampler's **AES1 & 2** outputs to the DAC's **AES1 & 2** inputs and select the DAC's **Dual AES** input. (It may be necessary to turn Dual AES mode on in the menu.)
- The transport will automatically slave to the Clock and display **Sync**.
- Set the Upsampler to sync to the external word clock.
- Use the DAC's **SYNC** button to set it to **WCik**.
- Connect the DAC's **Analogue Outputs** to a power amplifier or preamplifier.
- Set the DAC **Volume** control to a suitable level and play a disc.
- Set the Clock's **DITHER** feature on or off as you prefer.

### Using an External Reference

If you have a GPS receiver or an atomic clock with a 10MHz output, you can lock the *Paganini Clock* to it. These sources are even more accurate than the *Paganini Clock*, but note that low jitter and stability are more important than absolute accuracy.

- Use another BNC cable to connect the 10MHz output from the external reference to the *Paganini Clock*'s **Ref In** connector.
- Open the Clock's menu and set the **Coupling** menu page to **Bipolar**. The Clock should lock to the external reference and display **Sync**.
- Set the DAC **Volume** control to a suitable level and play some music.

The next step is crucial – sit back and enjoy the music.



### STEP 3 – USB Converter Applications

The USB interface can be connected to a PC running Windows™ 7, Vista (SP2 or later) or XP (SP3 or later), or Apple Mac™ OSX (10.5.4 or later) or a sound server, running software to generate PCM data.

If you do not want to use the USB interface, you can miss out Step 3.

#### Using the *Paganini Clock* with a computer and a *Paganini DAC*

Connect the system as shown below. You can use any of the *Clock*'s six **Word Clock Outputs**.

Set up the USB source as described on the next page and set the *Paganini DAC* to the **RCA1** input. When using a USB source, the *Clock* will automatically set its clock frequency to either 44.1 or 48kHz to suit the sample rate of the data stream on the **USB** input.

If you need to override the USB automatic frequency setting, use the **FREQUENCY** button. This is necessary if you play a 48, 96 or 192kS/s file (this sets the frequency to 48kHz) and then want to play a disc (which requires a 44.1 or 88.2kHz clock) while the computer is still running and connected.

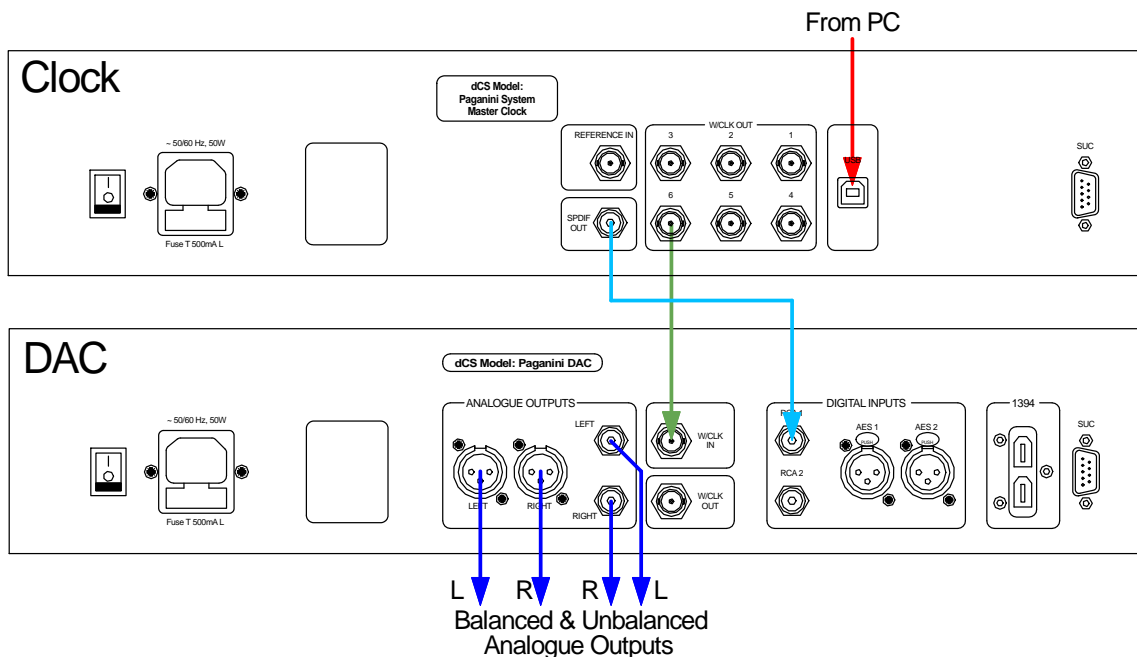

Figure 2 – Using the *Paganini Clock* with a computer and a *Paganini DAC*

The *Paganini Clock* re-packs the data into SPDIF format without processing.



*Paganini DAC* software v1.20 and later support playback of files sampled at 176.4 or 192kS/s through a single-wire SPDIF interface. At the time of writing, a future update is planned to add DoP capability to the DAC.

If your *Paganini DAC* is loaded with earlier software, please contact your distributor to request an update disc.

## A word about Music Playing Software

There are countless programs that can play music on Windows and Mac OSX systems. Unfortunately, not all of them present the data completely unprocessed to the USB ports. For example, Windows Media Player re-samples all data to 24 bits, albeit at the original sample rate, whilst iTunes rate converts data as necessary to the output sample rate set in the OSX Audio MIDI set-up panel.

With such a proliferation of playing software, and with updates being issued daily, it is impossible for *dCS* to be fully up-to-date with the behaviour and performance of all programs. If you have questions or problems, we would urge you to take them up with your software vendor. What we will say is that different programs operate very differently and it is well worth finding out exactly how your particular program processes the audio.

One particular problem that has been identified concerns the popular iTunes program when running on Windows systems. The default output word length is 16 bits and must be changed to 24 bits for correct operation. To do this, click on **Start > Control Panel > Quicktime**. Click on the **Audio** tab of the Quicktime panel and select **24 bit** in the **Size** field of the **Sound Out** section.

## Setting the USB Audio Class

There are two USB Audio classes, one of which must be set during system set-up. The Clock is shipped set to USB Audio Class 2.

**Audio Class 1:** The interface operates without a special driver at up to 96kS/s.

To select Class 1, press **Menu, →, Menu, →, →** to reach the **USB Class** menu page.



If you see this symbol, the Clock is already set to **Class 1**.



If you see this symbol, press the **Menu** button once to switch to **Class 1** and wait about 15 seconds.

The unit is now in Class 1 mode.

**Audio Class 2:** The interface operates at up to 192kS/s.

For Mac OSX, version 10.6 or later is required.

For Windows XP (SP3), Vista (SP2) or Windows 7, the driver files on the disc supplied must be loaded onto the computer before use (see the next page).

At the time of writing, we have not tested the driver with Windows 8, but we are told it works well if the driver is loaded in Windows 7 Compatibility Mode.

To select Class 2, press **Menu, →, Menu, →, →** to reach the **USB Class** menu page.



If you see this symbol, the Clock is already set to **Class 2**.



If you see this symbol, press the **Menu** button once to switch to **Class 2** and wait about 15 seconds.

The unit is now in Class 2 mode.

### Loading the Windows driver for USB Audio Class 2

- If ASIO4ALL or another ASIO driver is loaded on your computer, please uninstall it - otherwise the *dCS* driver will not work correctly.
- Make sure the Paganini Clock is set to USB Class 2 - otherwise the driver installation will fail.
- Power up the Clock and the computer. Do not connect the USB cable yet.
- Load the *dCS* USB Audio Class 2 driver disc for Windows into the computer's CD drive.
- If the installation does not start automatically, select "Run setup.exe".
- Follow the on-screen prompts.
- When prompted, connect the Clock to the computer's USB port.
- Wait until installation is complete (this takes a few minutes), then remove the driver disc and re-start the computer.



If you connect a *Paganini Clock* set for USB Audio Class 2 to a Windows computer without first loading the driver, the interface will not work and the computer will display the warning message: **Device cannot start**.

### Selecting the *Paganini Clock* as your Audio Output device



This section gives basic advice for setting up the computer. For more detailed advice and more advanced options, please visit [www.dcsLtd.co.uk/page/support](http://www.dcsLtd.co.uk/page/support) and download the current version of the "*dCS Guide to Computer Audio*".

Whichever program you are using to play your music, your computer may not automatically select your *Paganini Clock* as the preferred playback device. You can correct this as follows :

**Windows XP** - Once you have connected the *Clock* and switched it on, go to **Start > Control Panel > Sounds and Audio devices**. On the **Audio** tab, select **dCS Paganini Clock** from the drop down list in the **Sound Playback** Default device list.

**Windows Vista** - Once you have connected the *Clock* and switched it on, go to **Start > Control Panel > Hardware and Sound > Sound**. Select **dCS Paganini Clock** in the list of available devices on the **Playback** tab.

**Windows 7** - Once you have connected the *Clock* and switched it on, go to **Start > Control Panel > Sound**. Select **dCS Paganini Clock** in the list of available devices on the **Playback** tab.

**Apple Mac OSX** - Once you have connected the *Clock* and switched it on, open **Finder**, click on the **Go** tab and select **Utilities**. In the Utilities panel, select **Audio MIDI Setup** and click on **Audio Devices** in the Audio MIDI setup panel. Select **dCS Paganini Clock** from the drop down list in the **System Output** section. You can also set **dCS Paganini Clock** as the default output from the same panel.

## FRONT PANEL

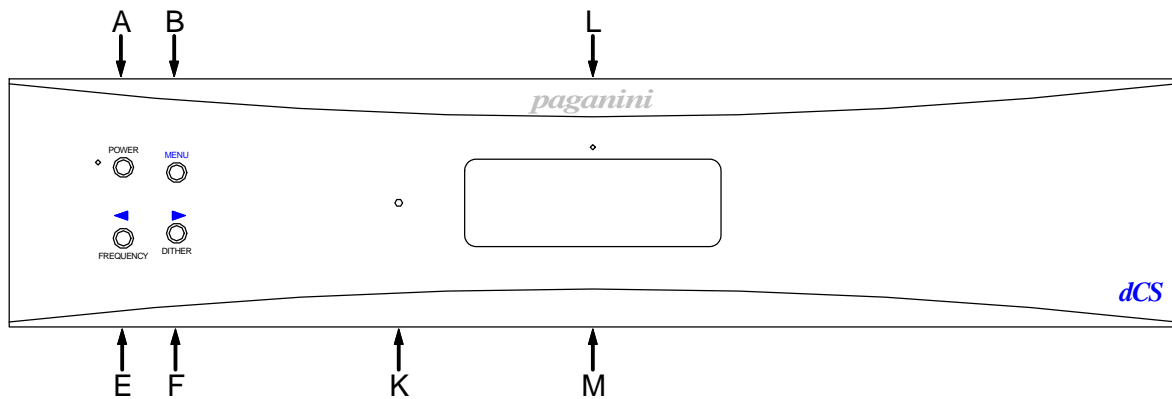

Figure 3 – Front panel

### POWER Button

To switch on, ensure the rear panel switch is set to **I** and press the **POWER** button (A) on the front panel once. Note that the unit cannot be turned on from the remote control.

To set the unit to sleep mode, press the **POWER** button once. The main display will turn off, the LED to the left of the button will light, and the clock outputs will mute, but the unit will remain close to running temperature. Press again to return to normal operation.

To switch off, hold down the **POWER** button for about 5 seconds until **Power Down** appears on the display, then release it.

When the menu is open, press the **POWER** button to close the menu.

### MENU Button

Press the **MENU** button (B) to open the menu, select menu pages and change settings. See the Menu section on page **16** for information on using the menu features.

### FREQUENCY Button

Use the **FREQUENCY** button (E) to set the clock frequency to either **44.1kHz**, **48kHz**, **88.2kHz** or **96kHz**. When the USB interface is connected, **Auto** mode is added to the list. The most common setting is **44.1kHz**.

When the menu is open, the **FREQUENCY** button changes to the **<** button, used to page backwards through the menu.

### DITHER Button

Press the **DITHER** button (F) to turn the Dither feature on and off. This dithers the clock edges in a controlled way to exercise the phase-locked-loops in the source and DAC. Try it and decide for yourself whether you prefer Dither on or off.

When the menu is open, the **DITHER** button changes to the **>** button, used to page forwards through the menu.

### Remote Control Receiver

Aim the remote control handset (supplied with the Transport) towards the receiver (K) for best sensitivity.

### Display

With no connection to the **USB** input and the Clock **Frequency** set to 44.1kHz, the display (M) might look like this:



The icons at the bottom show the current settings or operating conditions. From the left, these are:

- Temperature stabilised, if the icon is displayed. As the room temperature changes, this icon will disappear briefly and then reappear as the Clock settles again.
- **Dither** on, if this icon is displayed.
- When **Lock** is on, the Clock will not respond to remote control Frequency commands.

When the **USB** input is connected to a computer, the display changes to show the clock frequency on the left and the sample rate being received on the **USB** input on the right. The Clock Frequency will automatically change to **Auto**. In this mode, the Frequency will be either 44.1kHz or 48kHz to be consistent with the sample rate being received on the **USB** input. If you wish, you can over-ride the **Auto** setting with the **Frequency** button.



If the unit is locked to an external reference, **SYNC** is displayed on the bottom line. If an external reference is connected but the unit cannot lock to it or is in the process of locking to it, **SYNC** is displayed greyed out.

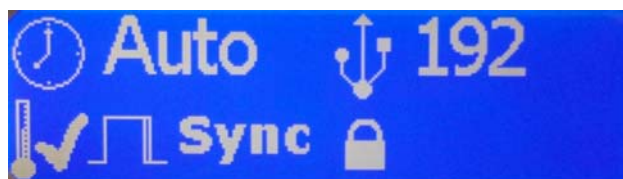

Details of the menu displays are shown in the Menu section on page 16.

If the display is turned off on the **Display Settings > Display Off** menu page, the LED (L) above the display lights. Selecting the **Display Off** menu page again turns off the LED also.

## REAR PANEL

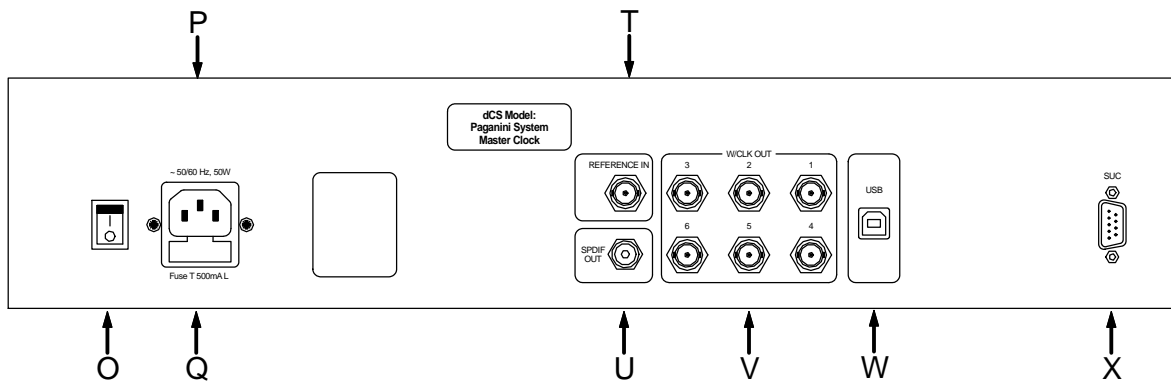

Figure 4 - Rear Panel

### Mains inlet

Power is connected via a standard IEC320 connector (P), protected by a fuse (Q) and isolated by a 2-pole power switch (O).

### Reference Input

The **Reference In** connector (T) on a BNC connector allows the unit to be locked to an even more accurate external reference, such as an atomic clock or a GPS receiver. The unit will lock to an external signal at 32, 44.1, 48, 88.2 or 96kHz or 1, 5, or 10MHz. With the **Coupling** menu page set to **TTL**, it will detect a DC-coupled word clock. With the **Coupling** menu page set to **Bipolar**, the unit will lock to an AC reference.

As the *Paganini* Clock is a grade 1 master clock, there is nothing to be gained by locking it to a less stable or less accurate reference!

This input is also used during a **CD Update** routine for loading new software via a CD transport.

### SPDIF Output

The **SPDIF Output** (U) on an RCA phono connector carries the same data at the same sample rate that is present on the **USB** interface, if it is active. The data is reformatted to SPDIF but is not processed.

### Word Clock Outputs

The unit has six identical **W/Cik Outputs** (V), all of which carry standard word clock at either 44.1, 48, 88.2 or 96kHz. Word clock is used for synchronisation only, it does not carry digital data.

## USB Interface

The **USB** interface on a 'B' type connector (W) will accept PCM data at up to 24 bits / 192kS/s from a Windows™ PC, Apple Mac™ PC or sound server equipped with a USB interface. This interface operates in asynchronous USB mode, which makes the *Paganini Clock* immune to clock jitter from the computer / sound server. The timing is set by the internal master clock. Feedback through the USB cable to the computer controls the rate of data delivery.



We have tested this interface with several common formats running on Windows 7, Windows Vista (SP2), Windows XP (SP3) and Apple Mac OSX 10.6 & 10.7 with various PCM streaming programs but we cannot accept responsibility for correct operation with all source devices, operating systems or software.



The **USB** interface is designed to work with a computer or sound server. Nothing useful will happen if you connect the interface directly to an MP3 player or a flash stick.



Please see page **10** for details on setting up the interface to Class 1 (up to 96kS/s without special drivers) or Class 2 (up to 192kS/s plus DoP, no special driver is required for OSX 10.6 & 10.7, the dCS Class 2 driver is required for Windows).

## SUC Connector

The **SUC** connector (X) is an RS232 interface, primarily used to remotely control the unit during automated testing. Please contact *dCS* for advice on using this interface with a household automation system. Note that we recommend using infra-red remote control instead.

## THE MENU

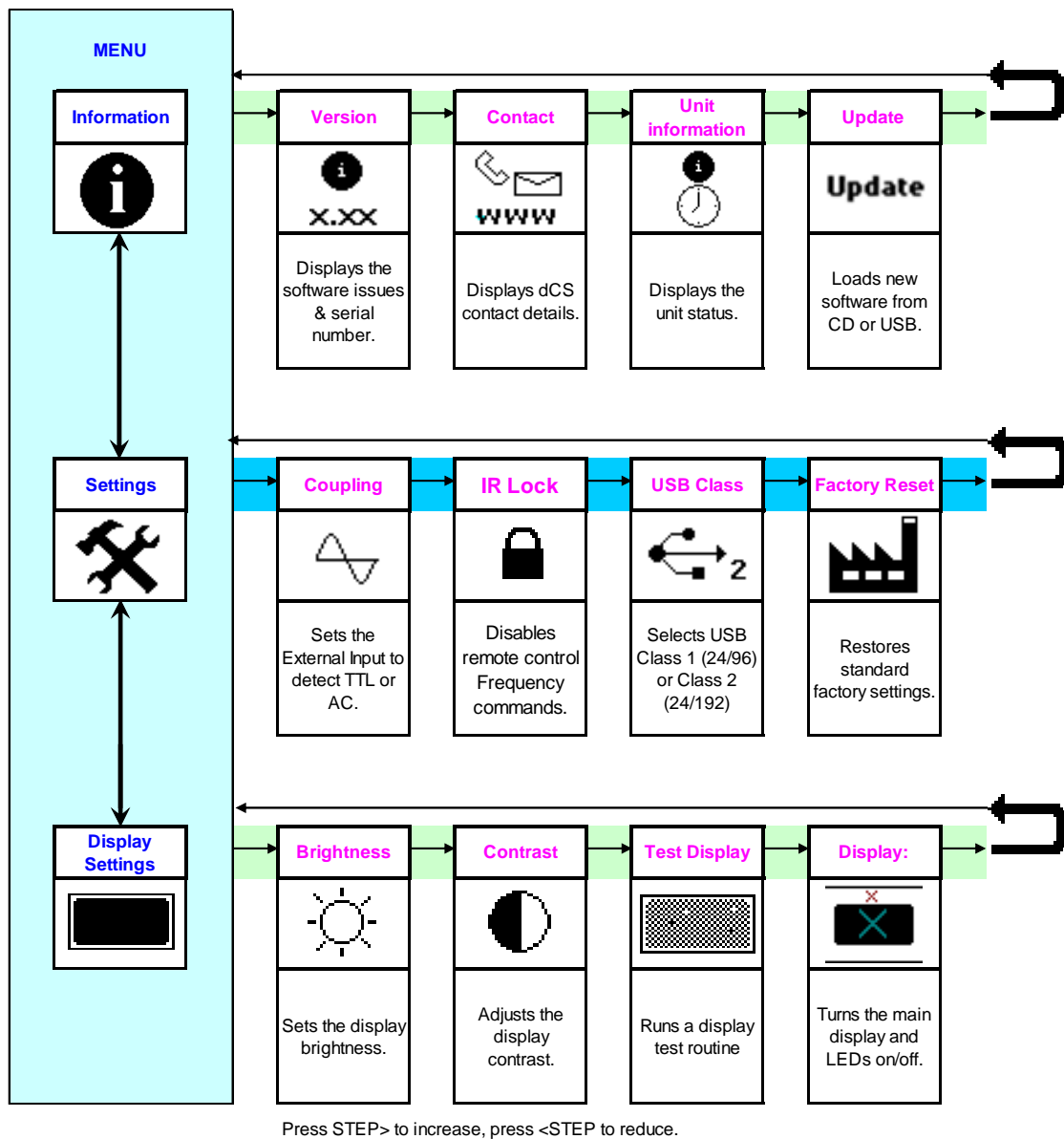

Figure 5 – The menu sequence



## Using the Menu

The menu gives the user access to a range of additional features. It also allows new features and performance enhancements to be added at a later date by software upgrades.

The menu is controlled by four buttons.



- Press the **MENU** button to open the menu or select a setting.
- Press the **>** button to page forward through the menu.
- Press the **<** button to page backward through the menu.
- Press the **POWER** button to close the menu or just wait 5 seconds.

Use the Menu Guide sheet to help you find the right menu.

Each unit in the range has either three or four top-level menu pages:



The **INFORMATION** menu gives software issues, serial number, contact details and unit set-up details.



The **SETTINGS** menu allows you to set some features that are not directly accessible from the front panel.



The **DISPLAY SETTINGS** menu is used to adjust and test the display.

Use the **>** button to move the highlight to the menu you want, then press the **MENU** button to select it. The next menu level down is displayed. Use the **>** button to move the highlight to the menu page you want, then press the **MENU** button to display the information or change the setting.



Select the exit icon to go back to the previous menu level.

## INFORMATION Menu



The **Version** page displays the software versions loaded in the unit and the full serial number. Please have this information ready if you contact your dealer for any reason.



The **Contact** page displays *dCS* web-site URL and email address. If you have any difficulty, please contact your dealer for help first.



The **Clock Information** page displays the unit status:

- Output frequency 44100 / 48000 / 88200 / 96000
- Coupling TTL / Bipolar / Off
- Dither on / off
- Temp ....°C
- Temperature Stable / Not stabilised
- Calibration OK / not OK
- Master / Slave mode
- Input freq ...Hz / No input
- USB Freq ....Hz

Use the < and > buttons to scroll down the list and the **MENU** button to exit.

## Update

The **Update** feature allows you to load new software into your system from either a disc or a file. Please follow the instructions supplied with the disc or file carefully.



**Update**

**CD Update** - load new software into the Clock from either a *dCS* transport or any STANDARD CD player / transport. Note that some non-Red-Book CD transports change the digital data and cannot be used to download new software.



**Update**

**USB Update** - load new software into the Clock from a computer via the USB interface, in a similar way as for a **CD Update**. The computer must be set to output bit-perfect data.



If you accidentally start an Update, switch off the unit at the back panel switch, wait 10 seconds, then switch on again.

## CLOCK SETTINGS Menu



The **Coupling** menu page sets the **Reference Input** to accept either an AC coupled **Bipolar** reference (generated by a GPS receiver, for example) or ...



... a DC-coupled Word Clock at **TTL** levels.



Set **Coupling** to **Off** when the **Reference Input** is not in use – this prevents the Clock trying to lock to stray signals.



The Settings **Lock** menu page prevents the Clock Frequency being changed accidentally by stray IR remote control commands.



**Unlock** to allow IR commands to change the Frequency.



The **USB Class** page sets the **USB** interface to either **Class 1** (44.1 – 96kS/s) or ...

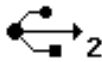

...**Class 2** (44.1 – 192kS/s or DoP).



The **Factory Reset** menu page resets the unit to standard settings. These are:

- **Frequency** to **44.1kHz**
- **Dither** to **Off**
- **Lock** to **Unlocked**
- **USB Class** to **2**
- **Display** to **On**
- **Brightness** to maximum
- **Contrast** to 60%.

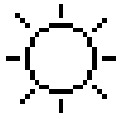
**DISPLAY SETTINGS Menu**

Set the display **Brightness** to a comfortable level using the < and > buttons.



Set the display **Contrast** to a comfortable level using the < and > buttons.

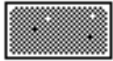

Runs a **Display Test** routine, which flashes all the indicators and the main display.



The **Display On / Off** menu page controls the display and LED indicator.



Select the page once and the display will turn off after the menu times out. The blue LED over the display illuminates to show the display has been turned off. Operating the controls turns the display back on briefly.



Select the page a second time to turn off the **DISPLAY OFF** LED also after the menu times out.

Select the page a third time to turn the display back on.

## SPECIFICATION

<b>Clock type</b>	Class 1 Master Clock with dual VCXO and microcontroller-enhanced temperature compensation.
<b>Clock Frequencies</b>	44.1, 48, 88.2 or 96kHz.
<b>Clock Accuracy</b>	Better than +/-1ppm when shipped (guaranteed for 12 months from shipping), typically +/-0.1ppm when shipped and stabilised.
<b>Word Clock Outputs</b>	6 independently buffered outputs on 75Ω BNC connectors, all carry the same clock frequency.
<b>USB Interface</b>	<p>USB interface on a B-type connector, will accept up to 24 bit PCM at:</p> <ul style="list-style-type: none"> <li>• 44.1, 48, 88.2 or 96kS/s when set to <b>Class 1</b> (no drivers required), or</li> <li>• 44.1, 48, 88.2, 96, 176.4 or 192kS/s when set to <b>Class 2</b> (no drivers are required for OSX 10.6 or later, drivers are required for Windows). DSD data in DoP format is passed through unprocessed.</li> </ul> <p>Operates in asynchronous USB mode.</p>
<b>SPDIF output</b>	SPDIF on 1x RCA Phono connector, outputs the same data at the same sample rate that is present on the USB interface, if it is active.
<b>Reference Input</b>	External Reference Input on 1x 75Ω BNC connector. Accepts word clock (with the <b>Coupling</b> menu page set to <b>TTL</b> ) or AC coupled signals (with the <b>Coupling</b> menu page set to <b>Bipolar</b> ) at 32kHz, 44.1kHz, 48kHz, 88.2kHz, 96kHz, 1MHz, 5MHz or 10MHz. Lock range is +/-300ppm.
<b>Start-up time</b>	Typically 1 minute to rated accuracy.
<b>Size and weight</b>	<p>460mm (18.1") W x 400mm (15.8") D x 110mm (4.4") H including feet. Allow extra depth for cable connectors. Allow space for air flow around the unit.</p> <p>Weight 10.5kg (23.1lbs).</p>
<b>Power requirements</b>	<p>Internally set to either 100, 115/120, 220 or 230/240V AC, 49 – 62Hz.</p> <p>Power consumption: 11W typical, 13W maximum.</p>

These specifications are subject to change without notice.

## MAINTENANCE AND SUPPORT

### Service and Maintenance

dCS audio products are designed not to need regular maintenance, and contain no user serviceable parts apart from the mains fuse. If your unit is damaged in any way, please contact your dealer.

### Replacing a Blown Mains Fuse

There is a mains fuse below the power inlet, accessible from the outside of the unit. If the fuse blows, it may be changed by the user. The current consumption of the unit is very low, so it only blows if power surges occur, or there is a fault in the unit. Usually power surges cause no other damage, but if the fuse blows repeatedly on replacement, some other damage will have been done and the unit will need to be repaired.

Fuse type: 20mm x 5mm T 0.5 amp L fuse



If the fuse should fail, it is essential that it is replaced with one of the same type and rating. Failure to do so could result in damage to the unit, risk of fire or electric shock and will invalidate the warranty.

Referring to the diagram below, remove the power cable, use a small flat bladed screwdriver to pry up the tab on the fuse carrier (A) and pull it out. Push the blown fuse out of the clip in the carrier (B) and dispose of it. Fit a new fuse in the clip (C) and push the carrier back into the unit so that it clicks home. Spare fuses are provided with the unit.

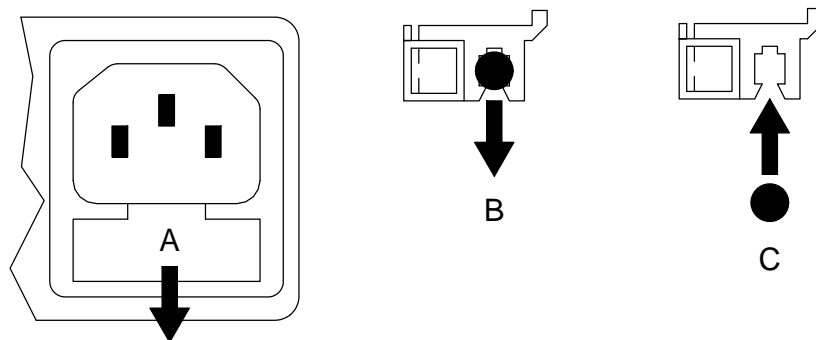

### Cleaning the case

The front panel of your dCS equipment is machined from very high grade aluminium. Great care has been taken to create the finish of the aluminium throughout the engineering process from the raw solid material to the finished piece.

To remove loose dust or finger marks from the case, we recommend that you use a clean, dry, lint-free cloth.

To restore the finish on the front panel, we recommend applying small quantities of a lanolin based cleaner, using a clean, dry, lint-free cloth and then wiping off. Do not allow lanolin to collect around the buttons.

Small amounts of glass cleaner containing ammonia may be used to clean other surfaces, but avoid spraying onto the connector contacts.

## Limited Warranty

### General

dCS warrants this product against defects in materials and workmanship for a period of 3 years from the date the unit was originally shipped from dCS. During the warranty period, dCS will repair or, at our absolute discretion, replace a faulty product. Warranty repairs must only be carried out by dCS or our authorised service agents. Please contact your dealer if your unit requires service.

Your dealer should have completed on your behalf an **Owner Registration** form at the time of sale and returned it to dCS. On receipt of the Owner Registration form, dCS will add your contact details to our customer database. dCS will use this information for warranty purposes only, we will not contact you directly for reasons relating to sales and marketing.

This warranty applies to the original owner.

### Warranty Exclusions

The Warranty does not cover wear and tear.

The Warranty on this product will be void if:

- the product is misused in any way.
- any unauthorised modifications or repairs are carried out.
- the product is not used in accordance with the Operating Conditions stated in this manual.
- the product is serviced or repaired other than by dCS or our authorised service agents.
- the product is operated without a mains earth (or ground) connection.
- the unit is returned inadequately packed.

dCS reserve the right to apply a service charge if a product returned for warranty repair is found to be operating correctly, or if a product is returned without a returns number being issued.

This warranty covers parts and labour only, it does not cover shipping charges or tax/duty.

Our dealers or distributors are NOT authorised to extend the terms of this warranty, dCS cannot accept responsibility for any attempt to do so.

Products re-sold by dCS on a “used” basis may be subject to reduced warranty terms.

### Obtaining Service

Should you encounter a problem, contact your authorised dCS dealer for advice, quoting the model, the full serial number, software version number, and giving a detailed description of the fault. Your dealer will advise you fully on actions that need to be taken. When returning a unit, the original packaging should be used to avoid transit damage. Replacement packaging sets may be purchased from dCS.

During the Warranty period, there will normally be no charge for parts or labour.

### Operating Conditions

- The supply voltage must remain within +/-10% of the A.C. voltage specified on the back panel.
- The supply frequency must be in the range 49Hz to 62Hz.
- Ambient temperature range: 0°C (32°F) to 40°C (104°F), non-condensing.
- Do not install the unit near heat sources such as radiators, air ducts, power amplifiers or direct strong sunlight.
- If in doubt, the easy test is – the unit is happy to work anywhere a human is.

## If you need more help

In the first instance, you should contact your dealer. If they cannot resolve the issue, contact your national distributor.

Manufactured by:

Data Conversion Systems Ltd  
Unit 1, Buckingway Business Park,  
Anderson Road,  
Swavesey,  
Cambridge. CB24 4AE  
UK

[www.dcsLtd.co.uk](http://www.dcsLtd.co.uk)

This user manual may be downloaded free of charge from our web-site.

A bound copy of this manual may be ordered from *dCS*.

## Software History

*dCS* products make extensive use of software configurable chips – FPGAs and DSPs. This gives us the ability to update our products to add extra features, update digital interface standards or make performance improvements by loading new software. Occasionally, a hardware upgrade may be necessary also to increase the “capacity” of the electronics, add extra connectors or extra front panel controls.

Please note that not all software updates make an earth-shattering change. You should have a clear idea of what you expect to gain before updating to the latest issue. We recommend that you keep your software up to date. Check the *dCS* web-site for the latest software updates.

This manual is for *Paganini Clock* software version 2.0x.

Issue 1.00 - The first issue for hardware type PCK, output frequencies are 44.1 or 48kHz.

Issue 2.00 – **This version requires hardware type PCP, it will not run on hardware type PCK.**

Output frequencies are 44.1, 48, 88.2 or 96kHz.

Asynchronous USB to SPDIF converter added, operates at up to 24/192, output on **SPDIF Out**. The converter is locked to the master clock.

SPDIF input is now a **Reference Input**, allowing the unit to lock to an external reference.

**Coupling**, **Lock** and **USB Class** menu pages added. **LED Off** feature added.